



SOSEN LED Driver, Your Smart Choice

Specifications

SS-150VH-E Series LED Driver

Model: SS-150VH-EXXX

Description: 150W LED Driver

Rev.: V02

Release Date: 2024-12-20

SS-150VH-E Series LED Driver

SOSEN
LED DRIVER



LED DRIVER

VH-E Series



Features:

- ❑ Efficiency up to 94%
- ❑ Isolated dimming:0-10V,PWM,Resistor
- ❑ Timing and Negative logic programmable
- ❑ Communication Function With PC
- ❑ IP67
- ❑ Protections: SCP/OTP/OVP/OPP
- ❑ Type HL, suitable for hazardous locations
- ❑ Surge protection: CM: 10kV, DM: 6kV
- ❑ Warranty: 5 years



Description:

VH-E series are constant current LED Driver with wide O/P voltage range and adjustable O/P current by program. LED luminaries manufactures can easily design luminaries and reduce cost.

Applications:

High Pole lighting, High bay lighting, Stadium lighting, Plant lighting, Street lighting, Fish lighting, Stage lighting, Tunnel lighting

Model List:

Model	AC Input Range	Max. Pout	Vout Range	Full Power Vo Range	Iout	Default Current	THD(Typ.)	PF(Typ.)	Eff.(Typ.)	Max.Tc
SS-150VH-E56B	90-305Vac	151.2W	28-56V	36-56V	0.7-4.2A	3.6A	8%	0.98	93%	90°C
SS-150VH-E143B	90-305Vac	150W	72-143V	100-143V	0.35-1.5A	1.5A	8%	0.98	94%	90°C
SS-150VH-E215B	90-305Vac	151.2W	108-215V	143-215V	0.1-1.05A	1.05A	8%	0.98	94%	90°C
SS-150VH-E286B	90-305Vac	150W	143-286V	214-286V	0.1-0.7A	0.7A	8%	0.98	94%	90°C

Note:

1.Default Tested: at 220Vac, full load, Ta 25°C.

2.The performance of the LED Driver can be guaranteed within the full power Vo range.The voltage lower than full power Vo range, it is need to test the performance with the LED module.

SS-150VH-E Series LED Driver

Input Characteristics:

Parameter	Min.	Typ.	Max.	Remark
Rated AC Input Range	100Vac		176Vac	<Ta: 45°C, Derate when <120Vac
	176Vac		277Vac	<Ta: 55°C
AC Input Range	90Vac		305Vac	
Input Frequency Range	47Hz	50/60Hz	63Hz	
Max Input Current			1.8A	100Vac, Full load
Max Input Power			180W	100Vac, Full load
Max Inrush Current(120Vac)			60A	Cold start
Max Inrush Current(220Vac)			90A	Cold start
Max Inrush Current(277Vac)			120A	Cold start
No Load Power			7.5W	220Vac/50Hz, No Load
Power Factor	0.97	0.98		220Vac/50Hz, Full load
	0.90			100-277Vac/50Hz, 70-100% load
THD		8%	10%	220Vac/50Hz, Full load
			20%	100-277Vac/50Hz, 70-100% load

SS-150VH-E Series LED Driver

O/P Characteristics(SS-150VH-E56B):

Parameter	Min.	Typ.	Max.	Remark
O/P Voltage Range	28V		56V	Power derated @28-36V
Rated O/P Voltage	36V		56V	$P_o=V_o \cdot I_o=151.2W$, Full load
Rated O/P Current	2.7A		4.2A	4.2A for 36V, 2.7A for 56V
Adj. O/P Current (AOC) Range	0.7A		4.2A	AOC by programming
No Load Voltage			60V	
Efficiency @120Vac	89.0%	91.0%		O/P 36V/4.2A
Efficiency @220Vac	91.0%	93.0%		O/P 36V/4.2A
Efficiency @277Vac	91.0%	93.0%		O/P 36V/4.2A
O/P Current Tolerance	-5%		+5%	
O/P Current Ripple(PK-AV)		5%	10%	Full load
Start-up Current Overshoot			10%	Full load
Start-up Time			0.5S	120Vac, Full load
			0.5S	220Vac, Full load
Line Regulation	-2%		+2%	Full load
Load Regulation	-2%		+2%	
Temperature Coefficient	-0.03%/°C		+0.03%/°C	Tc:0°C~90°C
OTP	90°C	100°C	110°C	>Tc Typ., Current derating <Tc Min., Current recovery
Short Circuit Protection				Driver will not be damaged, Hiccup mode

SS-150VH-E Series LED Driver

O/P Characteristics(SS-150VH-E143B):

Parameter	Min.	Typ.	Max.	Remark
O/P Voltage Range	72V		143V	Power derated @72-100V
Rated O/P Voltage	100V		143V	$P_o=V_o \cdot I_o=151.2W$, Full load
Rated O/P Current	1.05A		1.5A	1.5A for 100V,1.05A for 143V
Adj. O/P Current (AOC)Range	0.35A		1.5A	AOC by programming
No Load Voltage			160V	
Efficiency @120Vac	89.0%	91.0%		O/P 143V/1.05A
Efficiency @220Vac	91.0%	94.0%		O/P 143V/1.05A
Efficiency @277Vac	91.0%	94.0%		O/P 143V/1.05A
O/P Current Tolerance	-5%		+5%	
O/P Current Ripple(PK-AV)		5%	10%	Full load
Start-up Current Overshoot			10%	Full load
Start-up Time			0.5S	120Vac,Full load
			0.5S	220Vac,Full load
Line Regulation	-2%		+2%	Full load
Load Regulation	-2%		+2%	
Temperature Coefficient	-0.03%/°C		+0.03%/°C	Tc:0°C~90°C
OTP	90°C	100°C	110°C	>Tc Typ., Current derating <Tc Min., Current recovery
Short Circuit Protection				Driver will not be damaged, Hiccup mode

SS-150VH-E Series LED Driver

O/P Characteristics(SS-150VH-E215B):

Parameter	Min.	Typ.	Max.	Remark
O/P Voltage Range	108V		215V	Power derated @108-143V
Rated O/P Voltage	143V		215V	$P_o=V_o \cdot I_o=151.2W$, Full load
Rated O/P Current	0.7A		1.05A	1.05A for 143V,0.7A for 215V
Adj. O/P Current (AOC)Range	0.1A		1.05A	AOC by programming
No Load Voltage			230V	
Efficiency @120Vac	89.0%	91.0%		O/P 215V/0.7A
Efficiency @220Vac	91.0%	94.0%		O/P 215V/0.7A
Efficiency @277Vac	91.0%	94.0%		O/P 215V/0.7A
O/P Current Tolerance	-5%		+5%	
O/P Current Ripple(PK-AV)		5%	10%	Full load
Start-up Current Overshoot			10%	Full load
Start-up Time			0.5S	120Vac,Full load
			0.5S	220Vac,Full load
Line Regulation	-2%		+2%	Full load
Load Regulation	-2%		+2%	
Temperature Coefficient	-0.03%/°C		+0.03%/°C	Tc:0°C~90°C
OTP	90°C	100°C	110°C	>Tc Typ., Current derating <Tc Min., Current recovery
Short Circuit Protection				Driver will not be damaged, Hiccup mode

SS-150VH-E Series LED Driver

O/P Characteristics(SS-150VH-E286B):

Parameter	Min.	Typ.	Max.	Remark
O/P Voltage Range	143V		286V	Power derated @108-143V
Rated O/P Voltage	214V		286V	Po=Vo*Io=150W, Full load
Rated O/P Current	0.53A		0.7A	0.7A for 214V,0.53A for 286V
Adj. O/P Current (AOC)Range	0.1A		0.7A	AOC by programming
No Load Voltage			300V	
Efficiency @120Vac	89.0%	91.0%		O/P 286V/0.53A
Efficiency @220Vac	91.0%	94.0%		O/P 286V/0.53A
Efficiency @277Vac	91.0%	94.0%		O/P 286V/0.53A
O/P Current Tolerance	-5%		+5%	
O/P Current Ripple(PK-AV)		5%	10%	Full load
Start-up Current Overshoot			10%	Full load
Start-up Time			0.5S	120Vac,Full load
			0.5S	220Vac,Full load
Line Regulation	-2%		+2%	Full load
Load Regulation	-2%		+2%	
Temperature Coefficient	-0.03%/°C		+0.03%/°C	Tc:0°C~90°C
OTP	90°C	100°C	110°C	>Tc Typ., Current derating <Tc Min., Current recovery
Short Circuit Protection				Driver will not be damaged, Hiccup mode

SS-150VH-E Series LED Driver

Other Characteristics:

Parameter		Min.	Typ.	Max.	Remark	
0-10V Positive Dimming (Configurable)	Dim Vmax	0V		12V	DIM+ source current 110uA. Dimming prohibits reverse connection Configurable to 0-5V	
	Dim Range	10%Iomax		100%Ioset		
	Rec.Dim Range	0V		10V		
10-0V Negative Dimming (Configurable)	Rec.Dim Range	0V		10V	DIM+ sink current I _{max} 40uA. Dimming prohibits reverse connection Configurable to 5-0V	
PWM Dimming (Optional)	PWM High	9.8V		10.2V	DIM+ source current 110uA. Dimming prohibits reverse connection	
	PWM Low	0V		0.3V		
	Frequency	1KHz		2KHz		
	PWM Duty	0%		100%		
Resistor Dimming (Optional)	Resistance	0Kohm		100Kohm	Not available with negative logic	
	Dim Range	10%Iomax		100%Ioset	DIM+ source current 110uA .	
0-10V Dim to Off	Dim off	0.7V	0.8V	0.9V	If the led is less than maximum rated output voltage of 75%,the luminaries may possibly have slight light when dim-to-off. Thus the whole lighting system needs to be tested	
	Dim on	0.8V	0.9V	1.0V		
10-0V Dim to Off	Dim off	9.0V	9.2V	9.4V		
	Dim on	8.8V	9.0V	9.2V		
Timing Curve(Optional)		By programming				Set by program
Lifetime(Tc≤75°C)		≥50,000 hours				80% load
MTBF		202,000 hours			220Vac,Full load, Ta=25°C (MIL-HDBK-217F)	
IP		IP67				
Tc		90°C				
Warranty		5 years			Tc: 75°C	
Net Weight		710g				
Dimension		165mm*66mm*37mm			L x W x H	

SS-150VH-E Series LED Driver

Environmental Requirements

Parameter	Min.	Typ.	Max.	Remark
Operating Temperature(Tcase)	-40°C	25°C	+90°C	
Storage Temperature	-40°C	25°C	+90°C	
Operation Humidity	10%RH		95%RH	
Storage Humidity	5%RH		95%RH	
Altitude	-65m		4000m	

Safety and EMI/EMS Standards

Certification	Standard	Status	Remark
UL/cUL	UL8750	✓	
ENEC	EN 61347-1:2015 EN 61347-2-13:2014 EN 61347-2-13:2014/A1:2017	✓	
UKCA	EN 61347-1:2015+A1:2021 EN 61347-2-13:2014+A1:2017 EN 62493:2015 BS EN 61347-1:2015+A1:2021 BS EN 61347-2-13:2014+A1:2017 BS EN 62493:2015	✓	
EAC	EN 61347-2-13:2014 EN61347-1:2008+A1:2011+A2:2013 TP TC 004/2011 TP TC 020/2011	✓	
RCM	AS/NZS61347.2.13	✓	
CCC	GB 19510.14-2009	✓	
CE	EN 61347-2-13:2014 EN61347-1:2008+A1:2011+A2:2013	✓	

EMI/EMS	Criterion	Remark
Conduction Emission	EN IEC 55015:2019+A11:2020	
Radiation Emission	EN IEC 55015:2019+A11:2020	
Harmonic Current Emissions	IEC/EN 61000-3-2:2019+A1:2021	Class C
Surge	IEC/EN 61000-4-5	DM: 6kV,CM: 10kV,Criterion B
Ring Wave	IEC/EN 61000-4-12;ANSI/C82.77-5-2017	DM: 6kV,CM: 6kV,Criterion B

SS-150VH-E Series LED Driver

Safety Test Items:

Safety Test Items	Technical Indicators			Remark
	UL Insulation Requirements	ENEC Insulation Requirements	CCC Insulation Requirements	
Insulation Requirements	UL Insulation Requirements	ENEC Insulation Requirements	CCC Insulation Requirements	
Input-Output	1600Vac	3000Vac	3750Vac	Reinforced insulation
Input-Case	1600Vac	1500Vac	1875Vac	Basic insulation
Input-Dim	1600Vac	3000Vac	3750Vac	Reinforced insulation
Output-Dim	1600Vac	1000Vac	1000Vac	Basic insulation
Output-Case	500Vac	1000Vac	1000Vac	Basic insulation
Dim-Case	500Vac	250Vac	500Vac	Basic insulation
Insulation Resistance	$\geq 10M\Omega$			Input-Output, Test voltage: 500Vdc
Ground Resistance	$\leq 0.1\Omega$			25A/1min
Leakage Current	$\leq 0.75mA$			277Vac

NOTE:

1. SOSEN warrants the LED Driver itself complies with EMC standard. However, LED Driver's EMC should be re-checked when integrated into lighting systems due to unexpected interference of components.
2. Please short (ACL and ACN), (V+ and V-), (Dim+ and Dim -) when Hi-pot test.
3. The CCC withstand voltage test needs to disconnect the built-in lightning protection tube. According to the IEC 60598-1:14 standard section 10.2, the “built-in lightning protection tube” can be marked on the nameplate to disconnect the discharge tube on testing.

Performance Curves:

Input Inrush Current

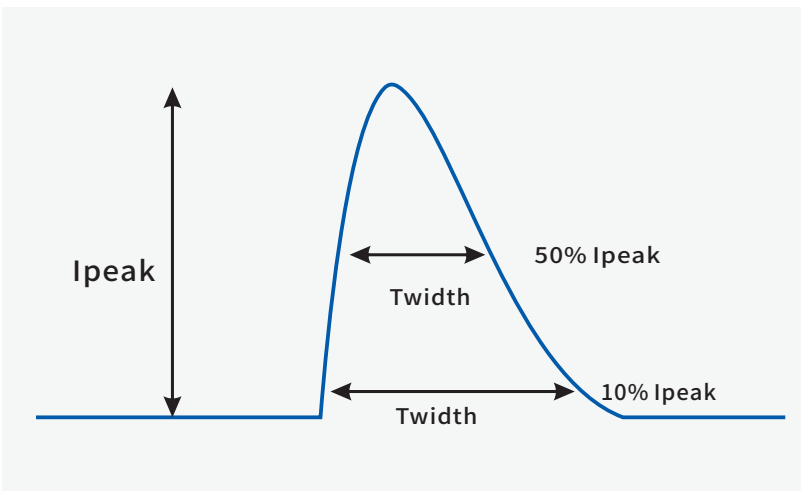

Vin	Ipeak	T(@10% of Ipeak)	T(@50% of Ipeak)
120Vac	60A	750uS	
220Vac	90A		300uS
277Vac	120A	550uS	

SS-150VH-E Series LED Driver

Performance Curves:

O/P Voltage Vs. O/P Current(Dim/AOC Window)

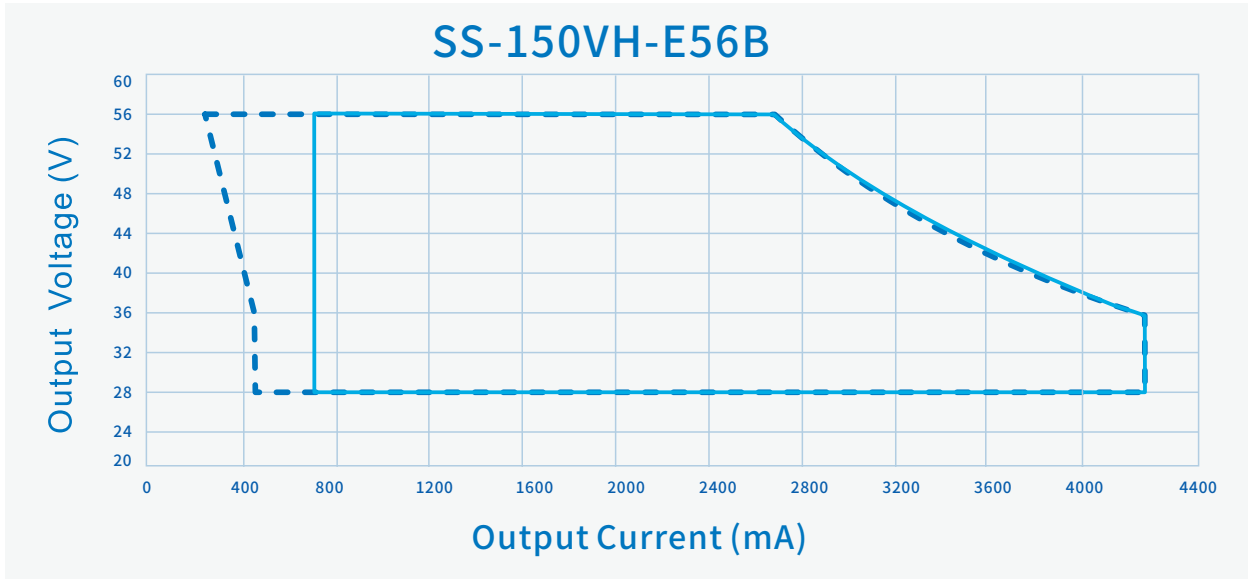

----- Dimming Window ————— AOC Window

O/P Voltage Vs. O/P Current(Dim/AOC Window)

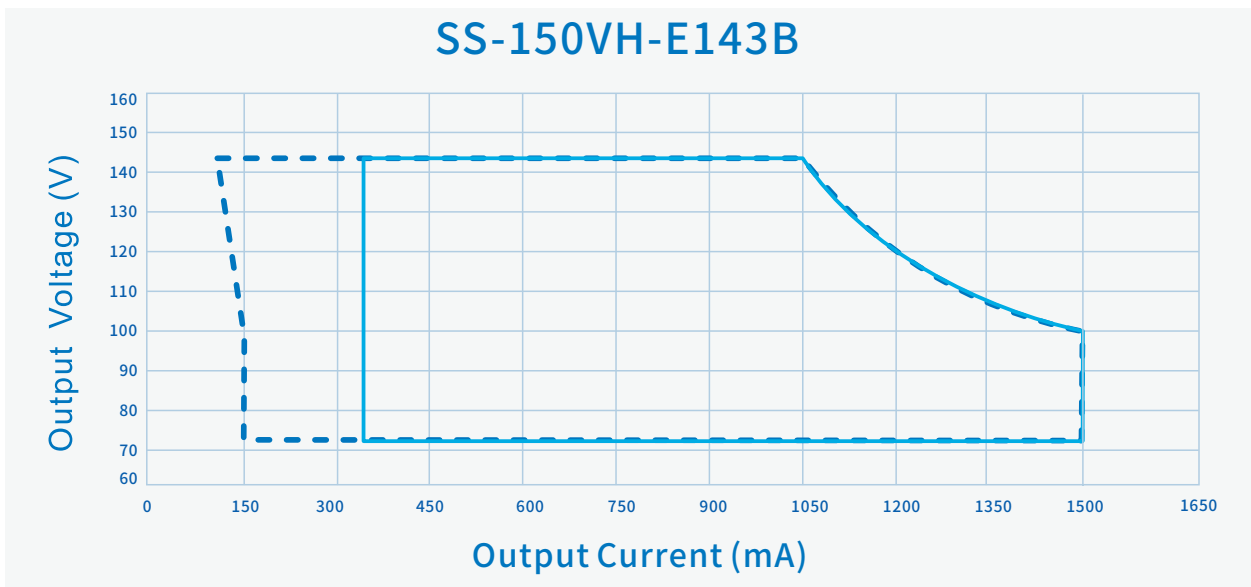

----- Dimming Window ————— AOC Window

SS-150VH-E Series LED Driver

Performance Curves:

O/P Voltage Vs. O/P Current(Dim/AOC Window)

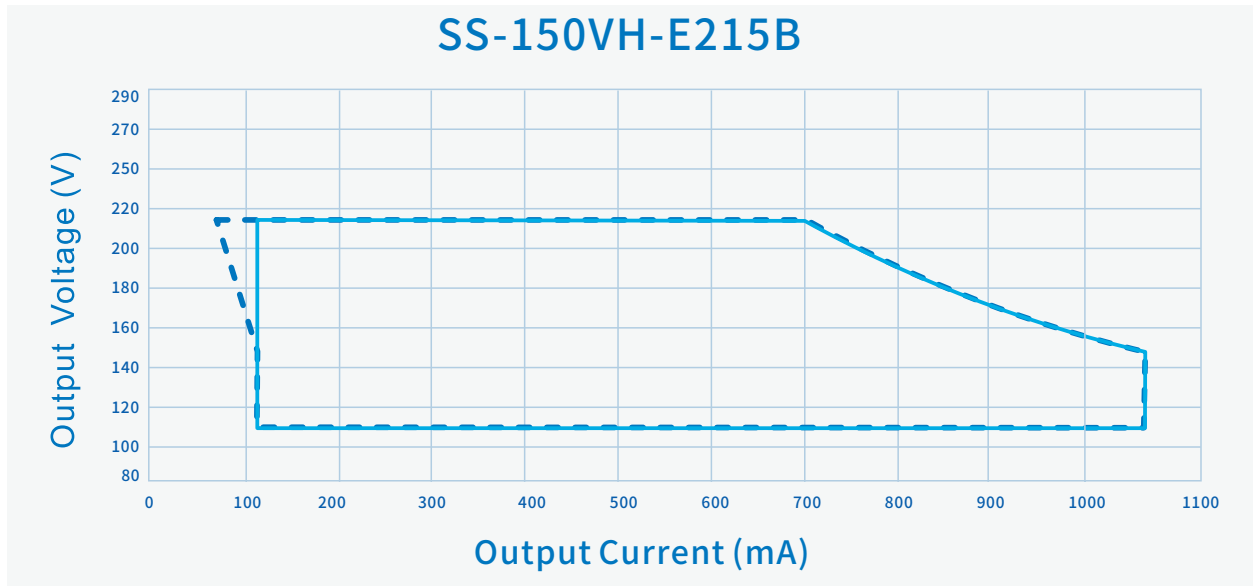

----- Dimming Window ————— AOC Window

O/P Voltage Vs. O/P Current(Dim/AOC Window)

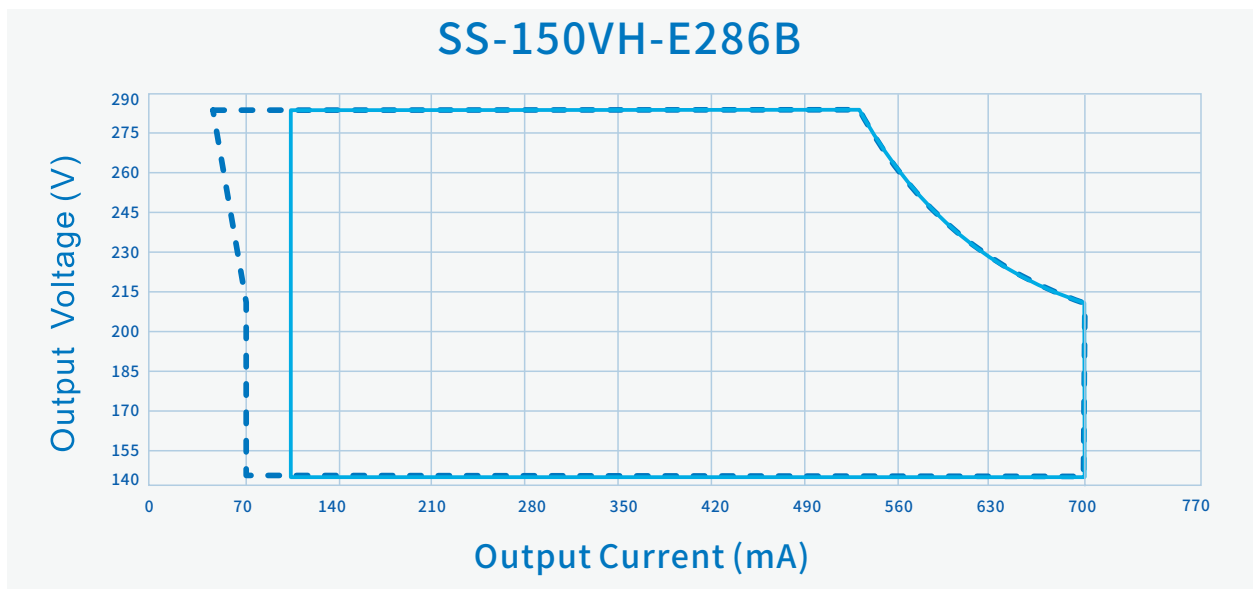

----- Dimming Window ————— AOC Window

SS-150VH-E Series LED Driver

Performance Curves:

Efficiency Vs. O/P Voltage ($V_{in}=120Vac$)

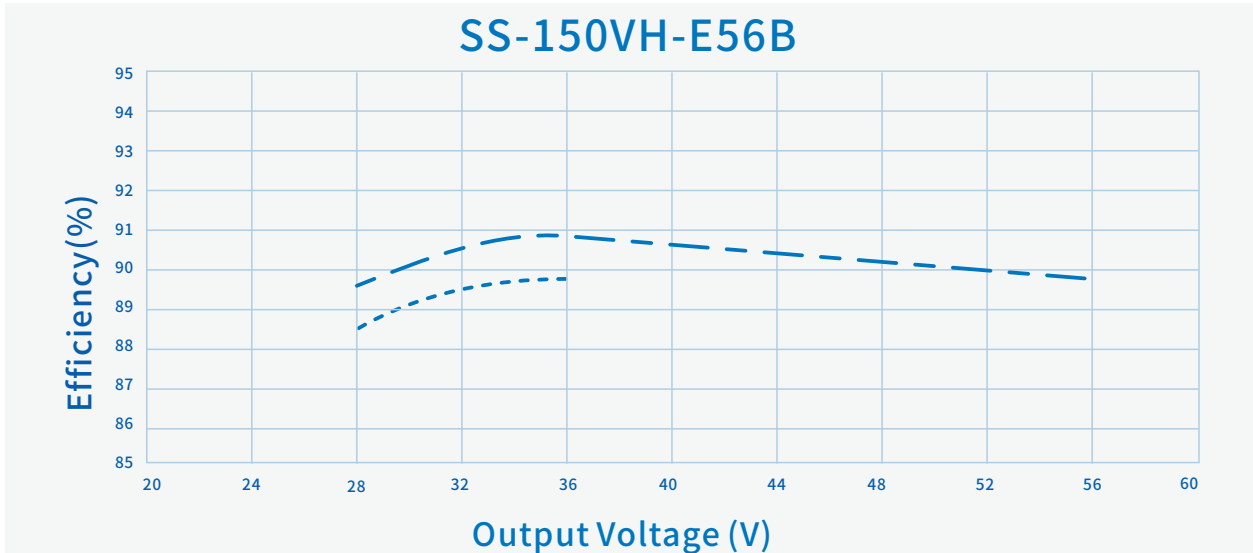

----- $I_o=4200mA$

- . - . $I_o=2700mA$

Efficiency Vs. O/P Voltage ($V_{in}=220Vac$)

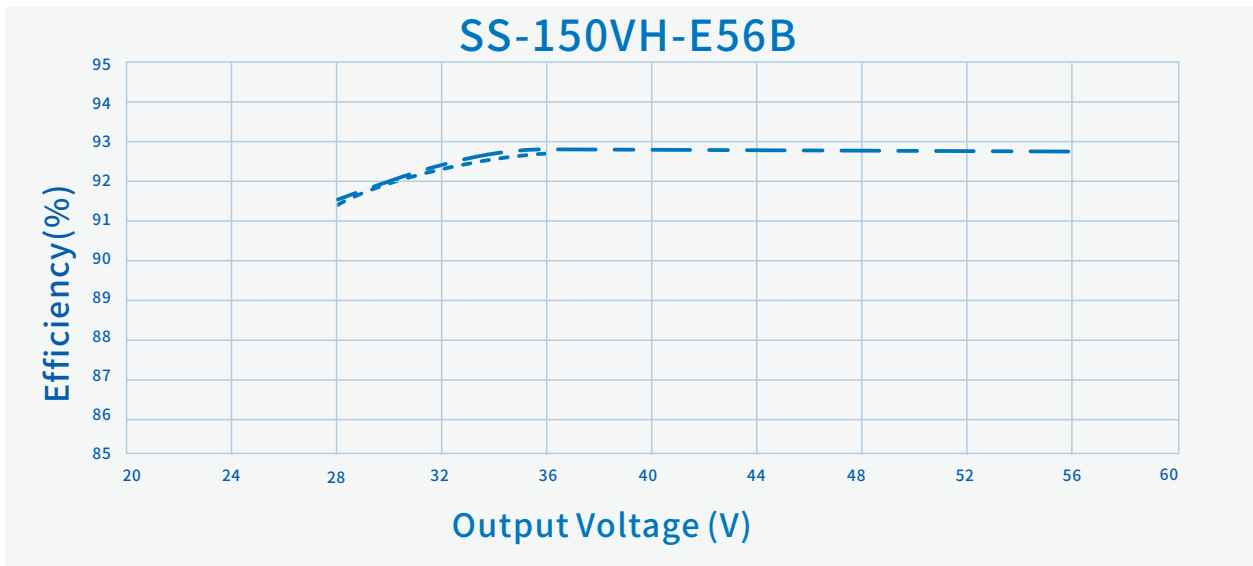

----- $I_o=4200mA$

- . - . $I_o=2700mA$

SS-150VH-E Series LED Driver

Performance Curves:

Efficiency Vs. O/P Voltage ($V_{in}=277V_{ac}$)

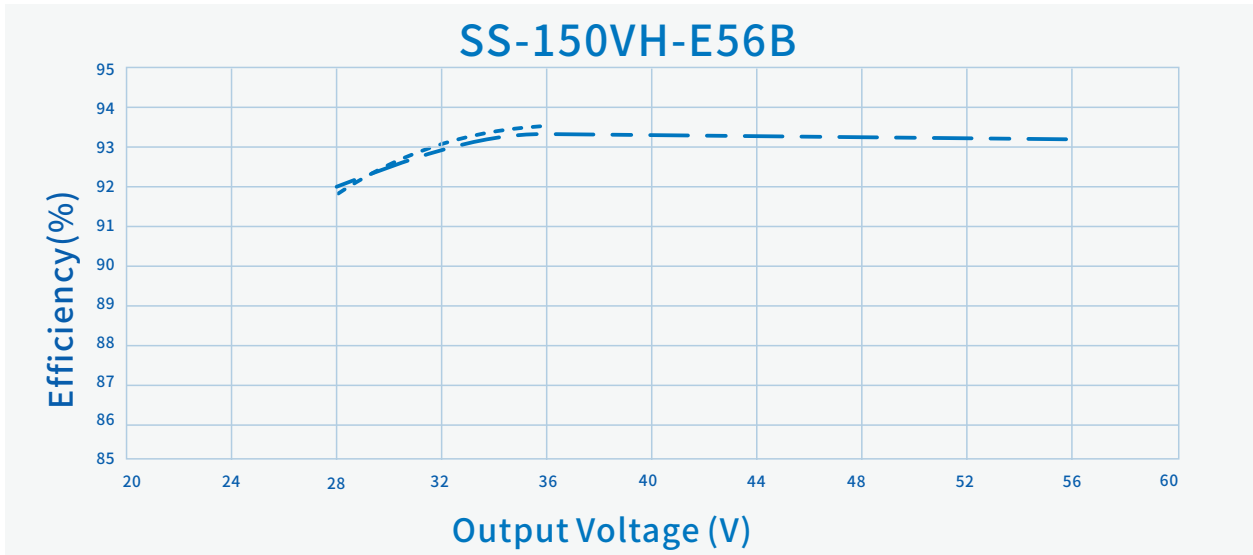

----- I_o=4200mA

— — — I_o=2700mA

Efficiency Vs. O/P Voltage ($V_{in}=120V_{ac}$)

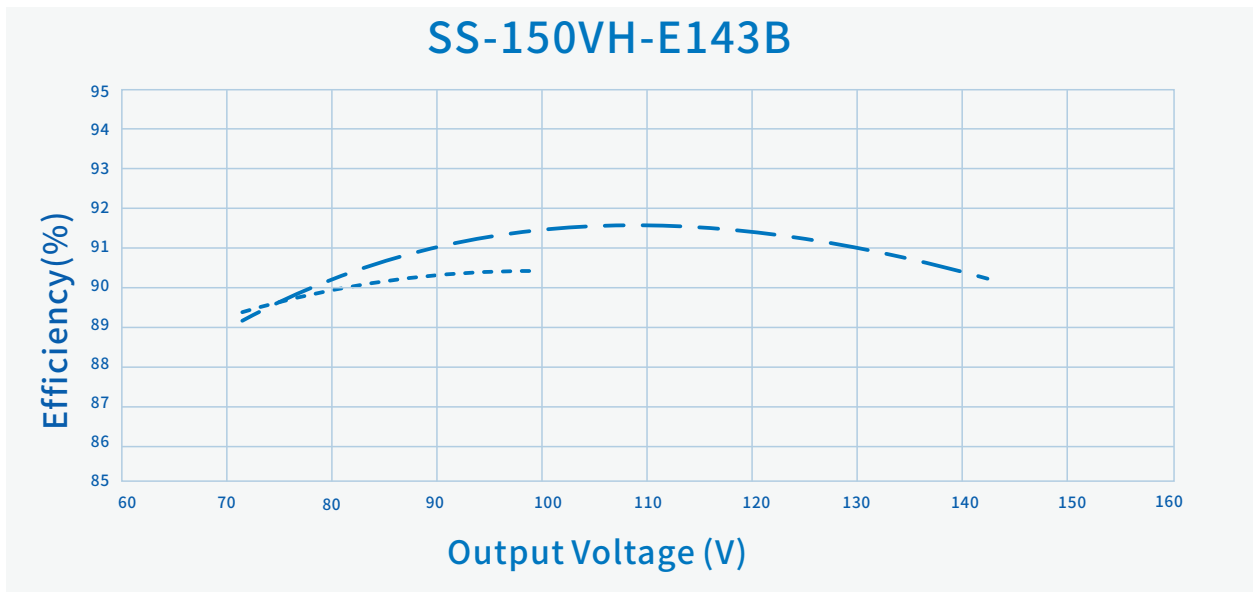

----- I_o=1500mA

— — — I_o=1050mA

SS-150VH-E Series LED Driver

Performance Curves:

Efficiency Vs. O/P Voltage ($V_{in}=220V_{ac}$)

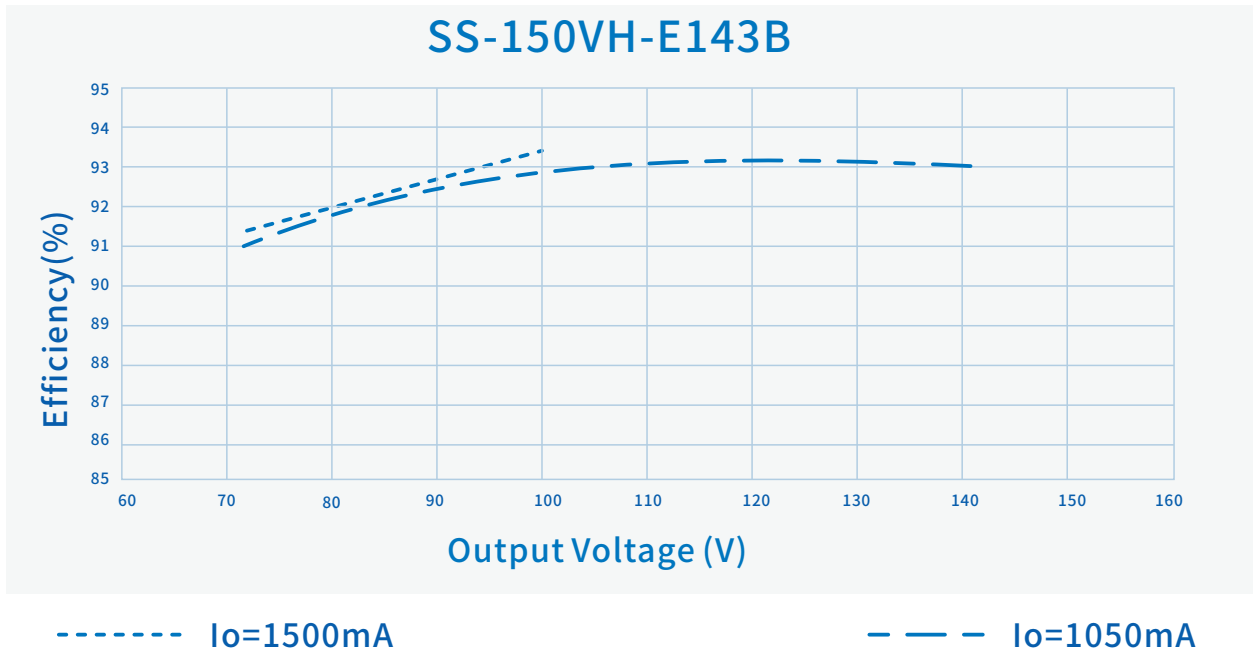

Efficiency Vs. O/P Voltage ($V_{in}=277V_{ac}$)

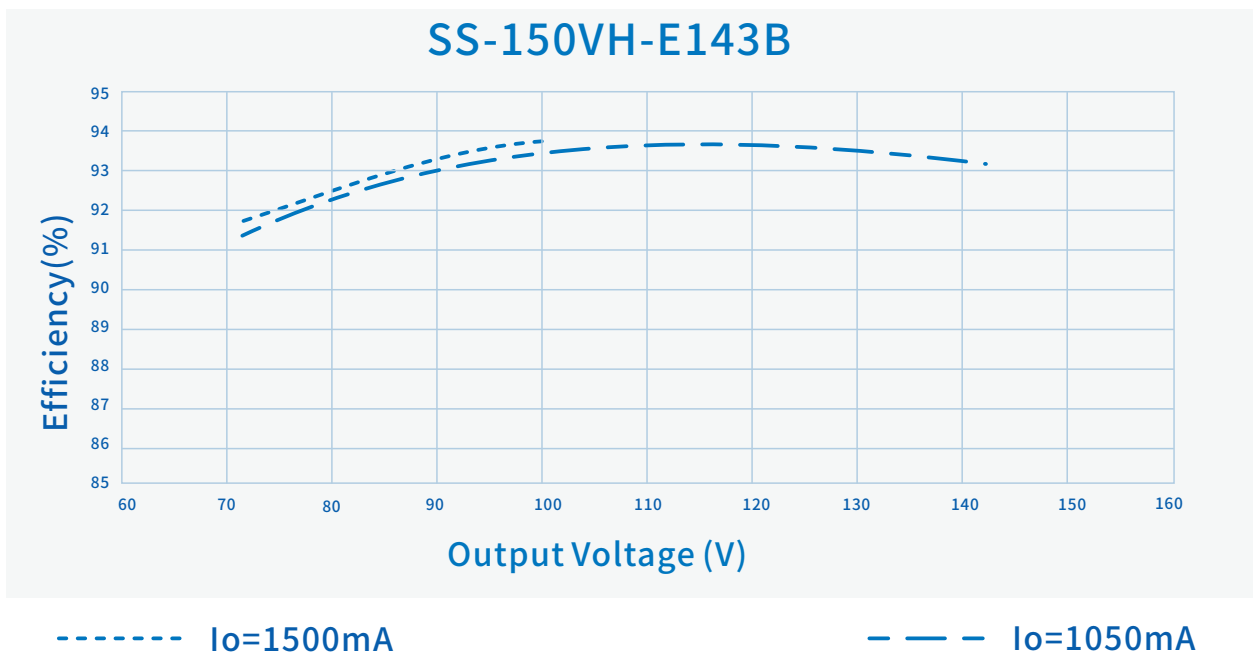

SS-150VH-E Series LED Driver

Performance Curves:

Efficiency Vs. O/P Voltage ($V_{in}=120V_{ac}$)

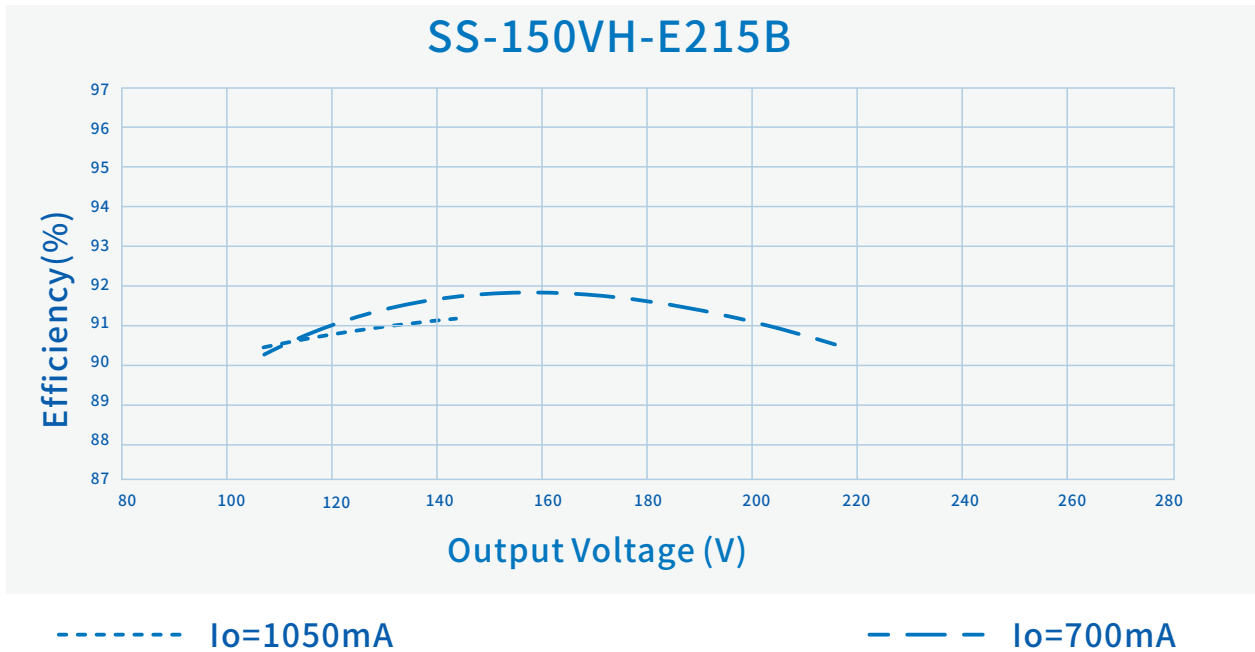

Efficiency Vs. O/P Voltage ($V_{in}=220V_{ac}$)

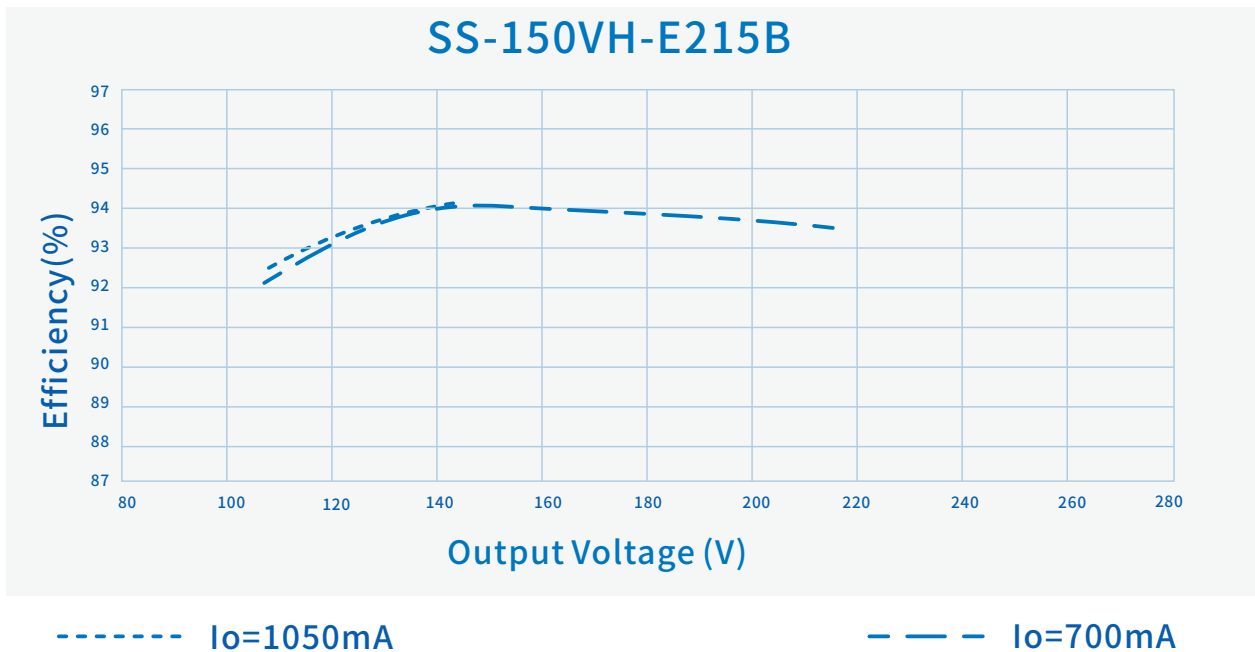

SS-150VH-E Series LED Driver

Performance Curves:

Efficiency Vs. O/P Voltage ($V_{in}=277V_{ac}$)

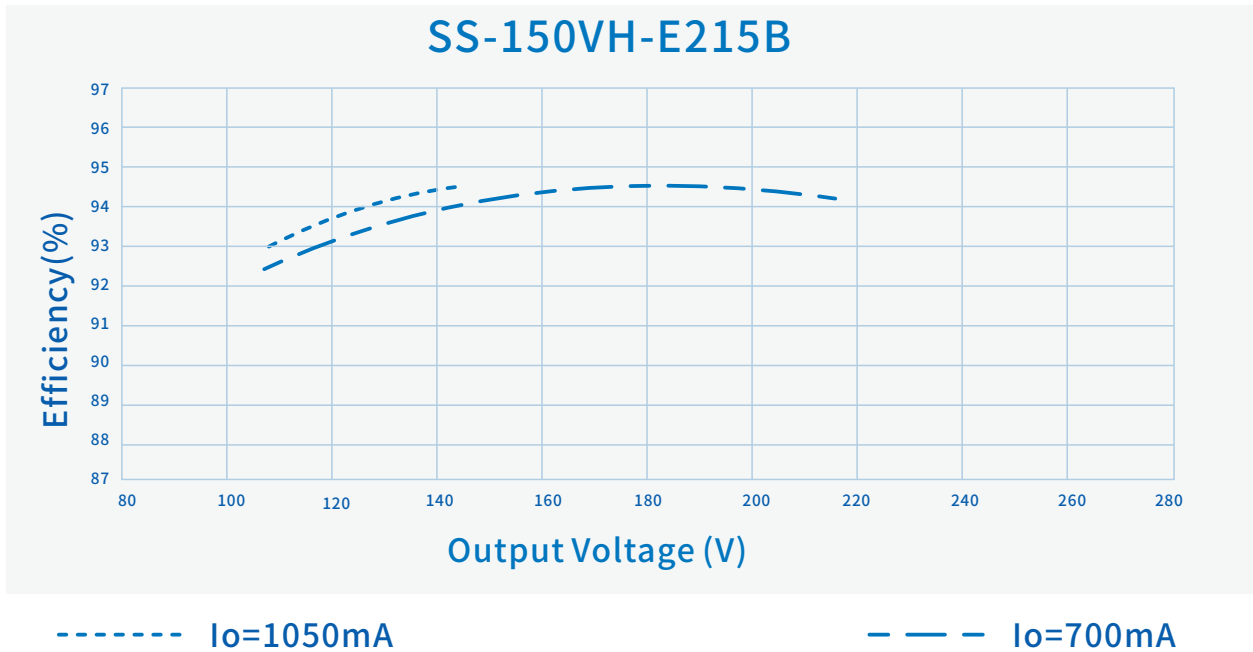

Efficiency Vs. O/P Voltage ($V_{in}=120V_{ac}$)

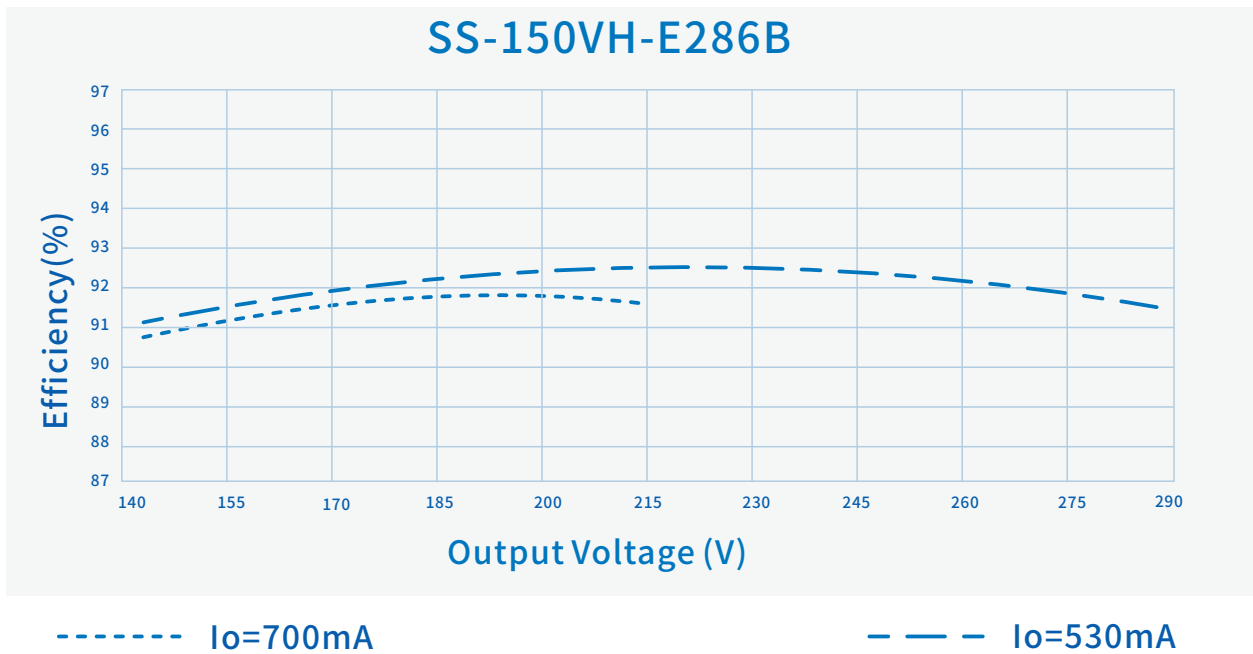

SS-150VH-E Series LED Driver

Performance Curves(SS-150VH-E56B):

Power Factor Vs. O/P Power

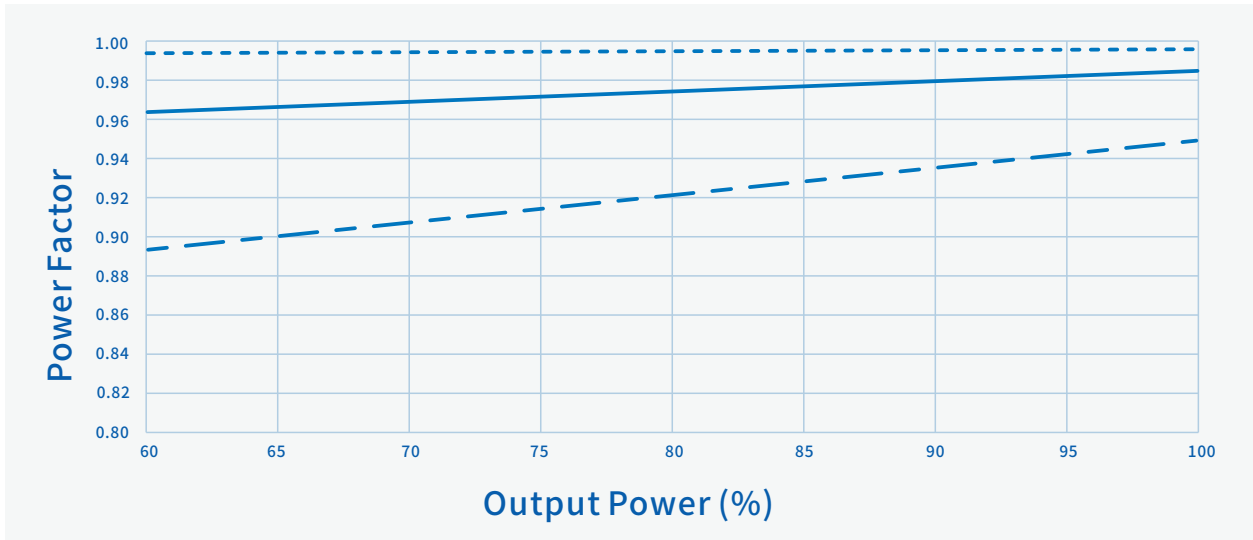

----- Vin=120Vac ——— Vin=220Vac - - - Vin=277Vac

THD Vs. O/P Power

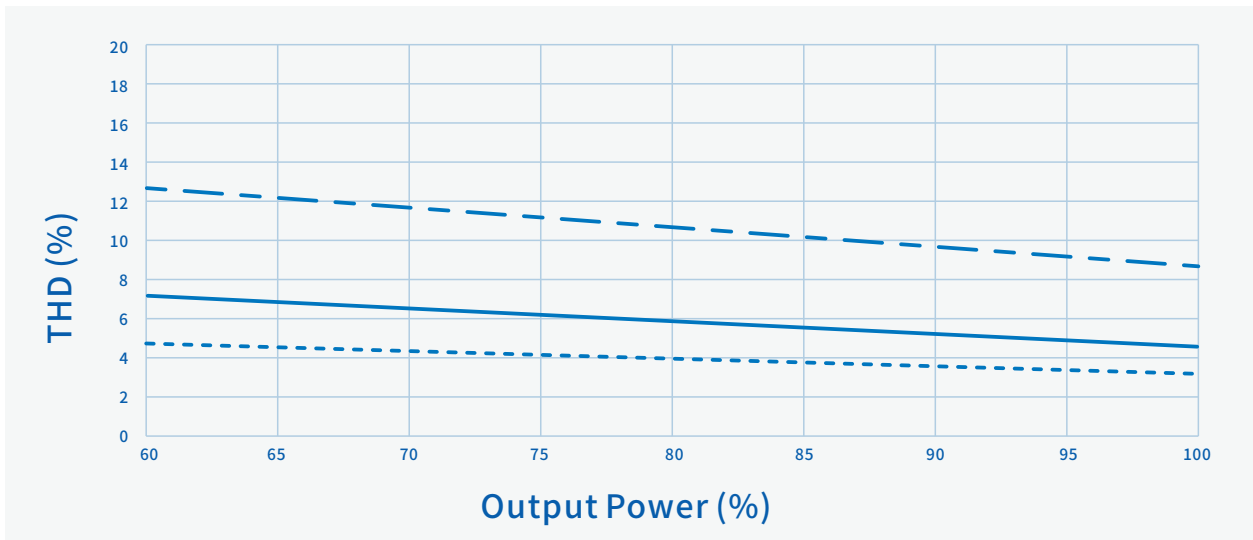

----- Vin=120Vac ——— Vin=220Vac - - - Vin=277Vac

SS-150VH-E Series LED Driver

Performance Curves(SS-150VH-E143B):

Power Factor Vs. O/P Power

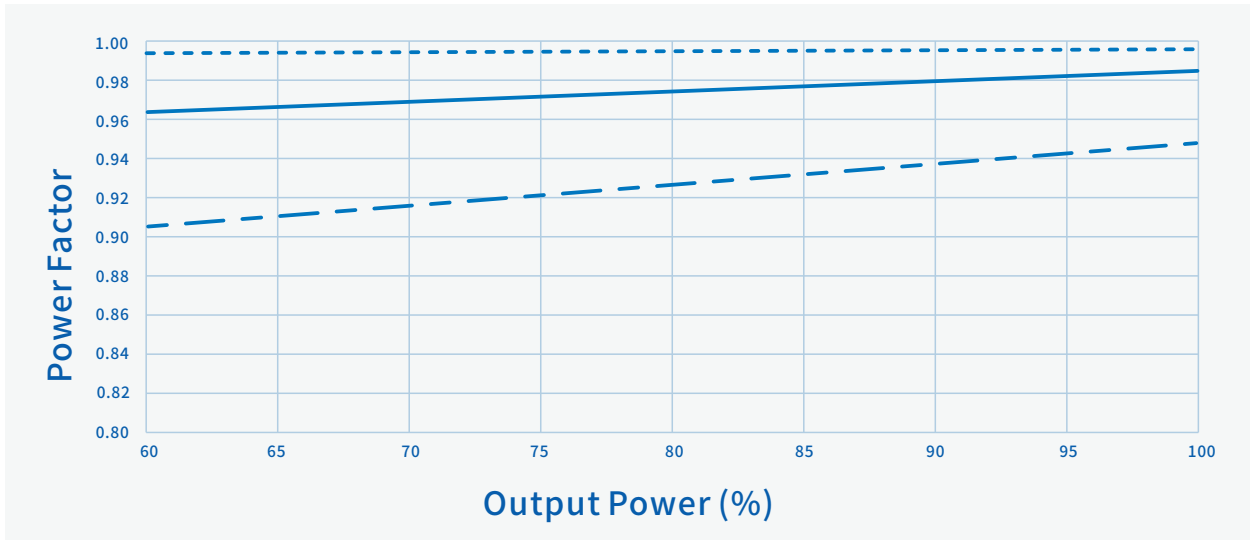

----- Vin=120Vac ————— Vin=220Vac - . - . Vin=277Vac

THD Vs. O/P Power

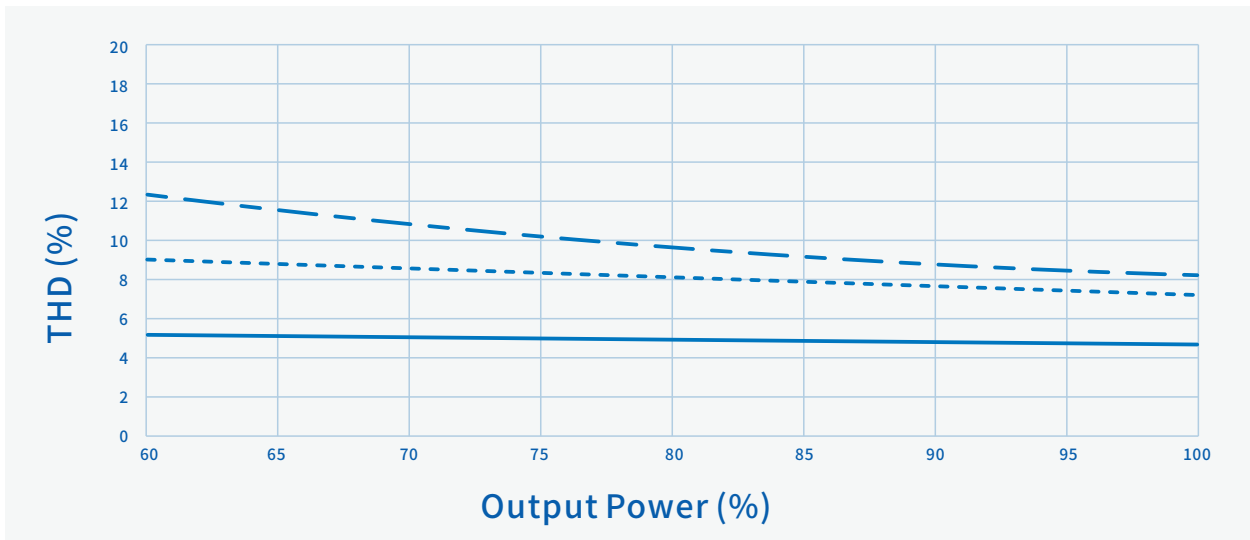

----- Vin=120Vac ————— Vin=220Vac - . - . Vin=277Vac

SS-150VH-E Series LED Driver

Performance Curves(SS-150VH-E215B):

Power Factor Vs. O/P Power

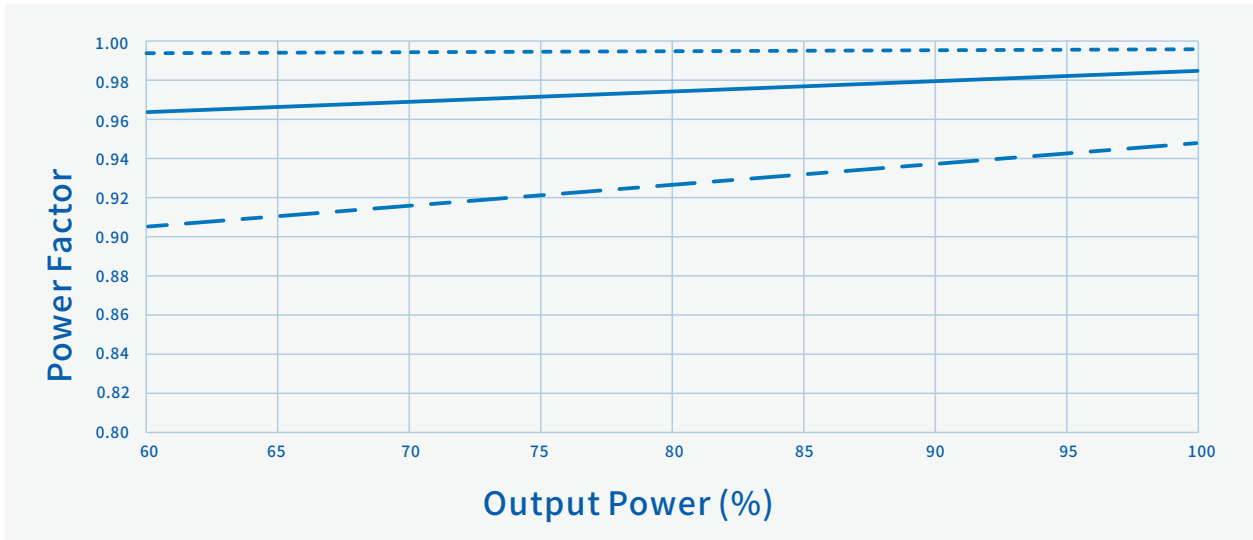

----- Vin=120Vac ————— Vin=220Vac - . - . Vin=277Vac

THD Vs. O/P Power

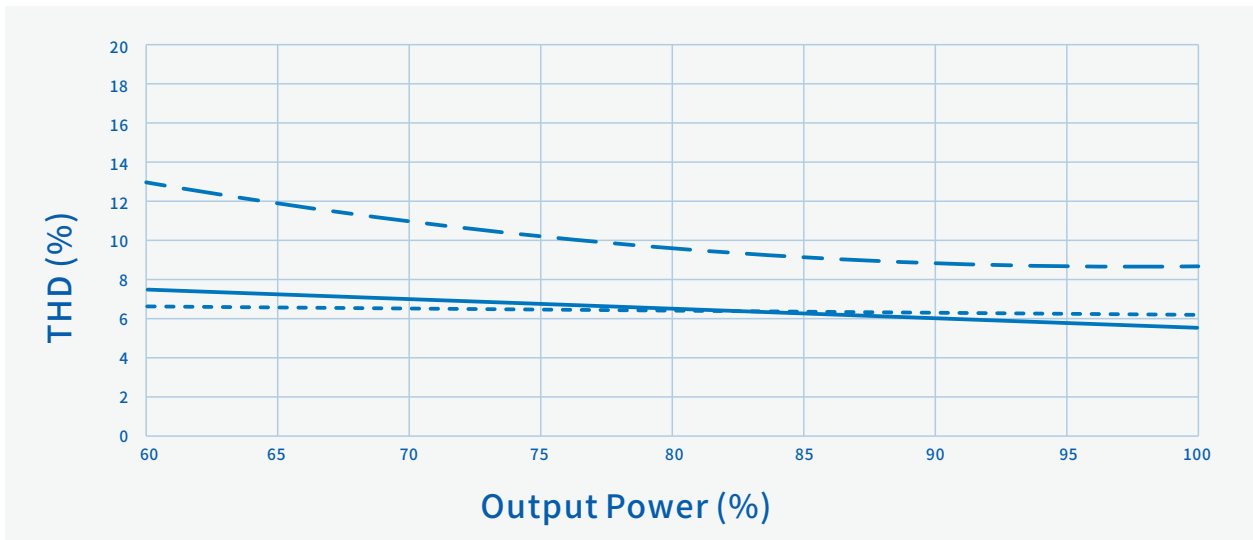

----- Vin=120Vac ————— Vin=220Vac - . - . Vin=277Vac

SS-150VH-E Series LED Driver

Performance Curves(SS-150VH-E286B):

Power Factor Vs. O/P Power

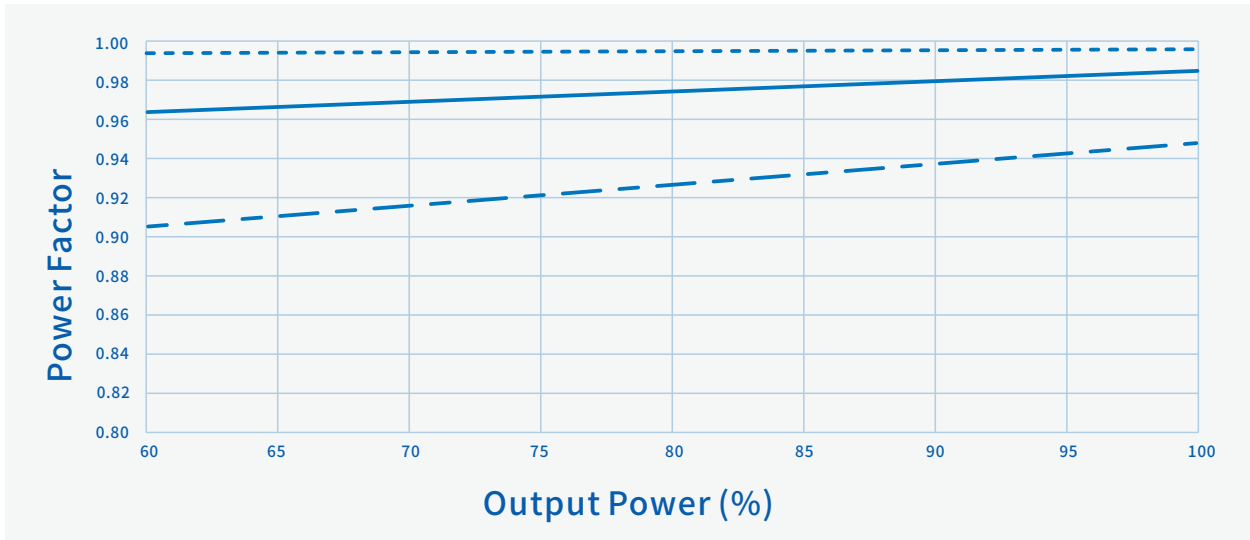

----- Vin=120Vac ————— Vin=220Vac - . - . Vin=277Vac

THD Vs. O/P Power

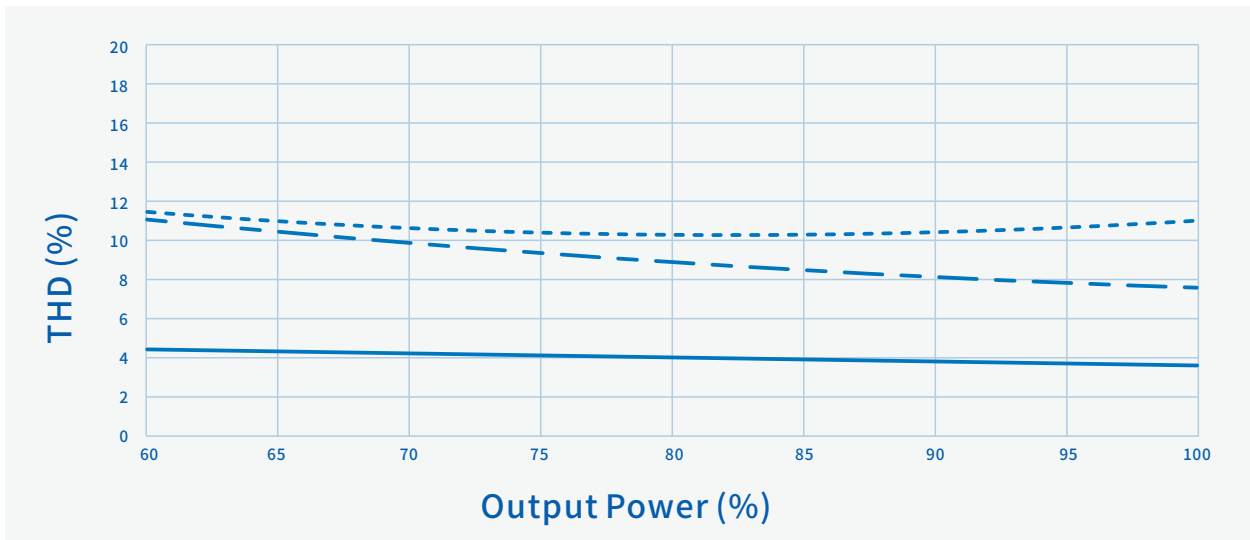

----- Vin=120Vac ————— Vin=220Vac - . - . Vin=277Vac

SS-150VH-E Series LED Driver

Performance Curves:

O/P power Vs. Input Voltage

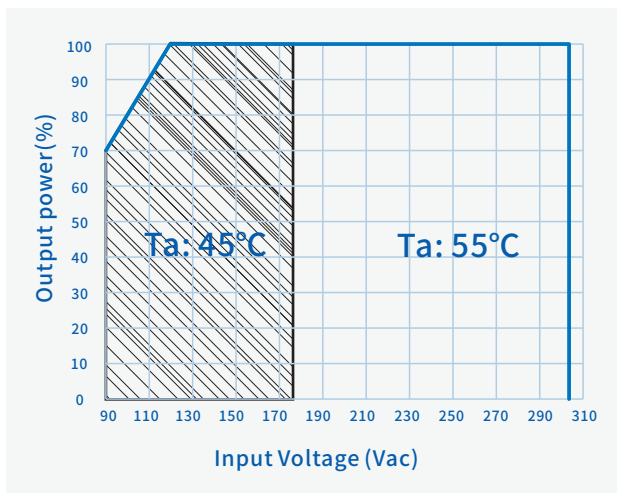

O/P power Vs. Case Temperature

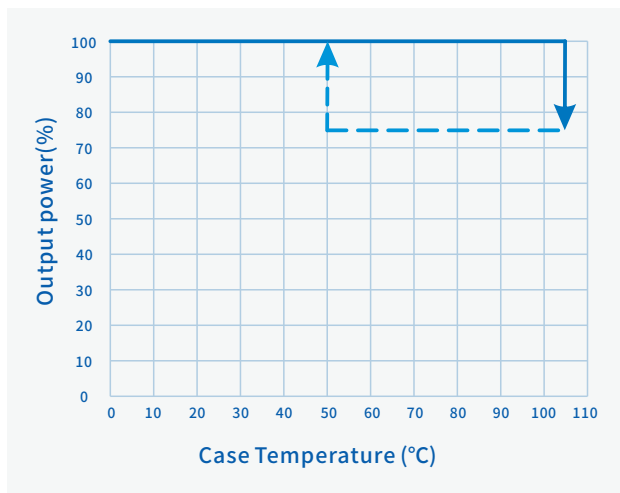

O/P Power Vs. Dimming

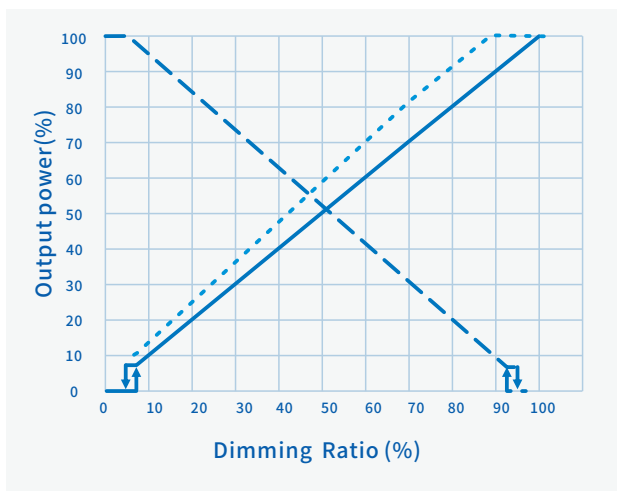

Lifetime Vs. Case Temperature

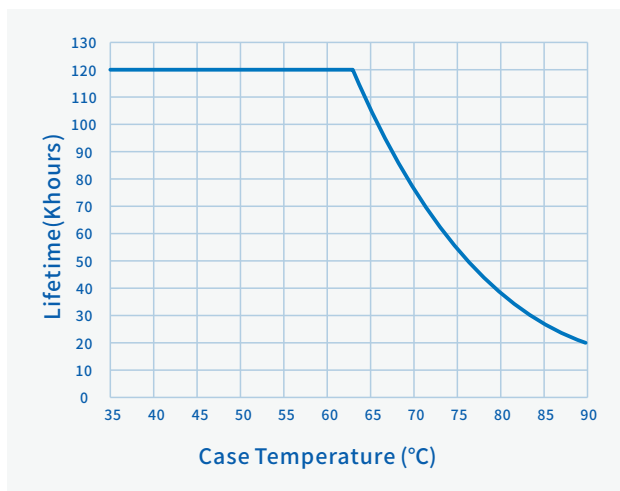

- 0-10V, 0-5V, PWM
- - 10-0V, 5-0V
- ... Resistor Dimming (100KΩ)

SS-150VH-E Series LED Driver

Constant Lumen Output

Constant Lumen Output are design to maintain fixture's stable output lumen by increasing driver's output current within driver's life span to counteract LED lumen degradation.

Programming connection diagram:

Legacy Timer: Driver's O/P follows the pre-programmed timing curve after turn-on.

Auto-Adjust by Percentage: Driver's O/P will be adjusted by automatically changed dimming curve by the period percentage based on the latest 5 dimming curve.

Auto-Adjust by Mid-point: Driver's O/P will be adjusted by automatically changed dimming curve by mid-point based on the latest 5 dimming curve.

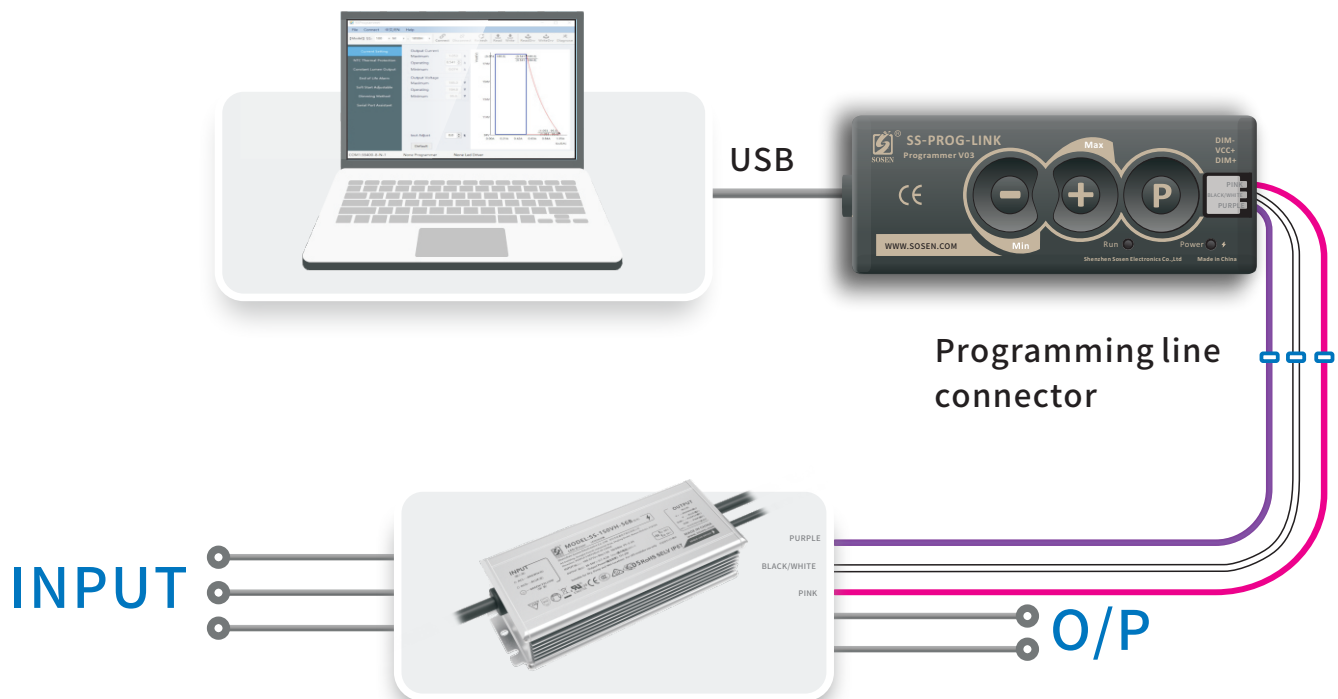

Note:

For details, please refer to the Sosen SS-PROG-LINK Programmer Manual.

SS-150VH-E Series LED Driver

Mechanical Characteristics

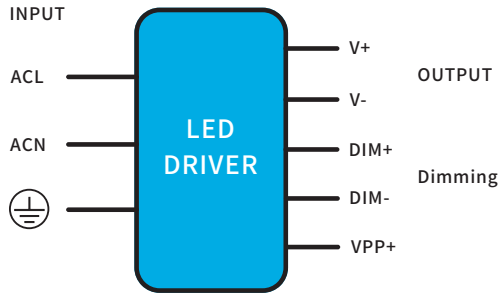

AC Input Cable (Exposed Length $450 \pm 10\text{mm}$):

UL model: SJTW, 3*18AWG, O.D: 7.8mm, Black:L, White:N, Green: \oplus

Global model: SJOW, 3*17AWG, O.D: 8.0mm, Brown:L, Blue:N, Yellow/Green: \oplus

DC O/P Cable (Exposed Length $250 \pm 10\text{mm}$):

UL model: SJTW, 2*18AW, O.D: 7.3mm, Red:V+, Black:V-

Global model: SJOW, 2*17AWG, O.D: 7.7mm, Brown:V+, Blue:V-

DIM Cable (Exposed Length $220 \pm 10\text{mm}$):

UL/EU model: STYLE 21996, 3*22AWG, O.D: 4.9mm, Purple: DIM+,

Pink: DIM-, Black/White: VPP+

Name Description	Standard Code	mm(In.)
Case Length	L3	148(5.83)
Case Width	W1	66(2.6)
Case Height	H	37(1.46)
Overall Length	L1	165(6.5)
Mounting Hole Length	L2	156(6.14)
Mounting Hole Width	W2	32(1.26)
TC Point Position	X	48(1.89)
TC Point Position	Y	33(1.3)

Note:

1, Please follow the "LED Driver User Manual" obtained from SOSEN's official website for assembly.

2, AC Input Cable, DC O/P Cable, DIM/AUX Power/Programming Cable: Peeled length of cable: $43 \pm 5\text{mm}$, Tinned length of wire: $10 \pm 2\text{mm}$

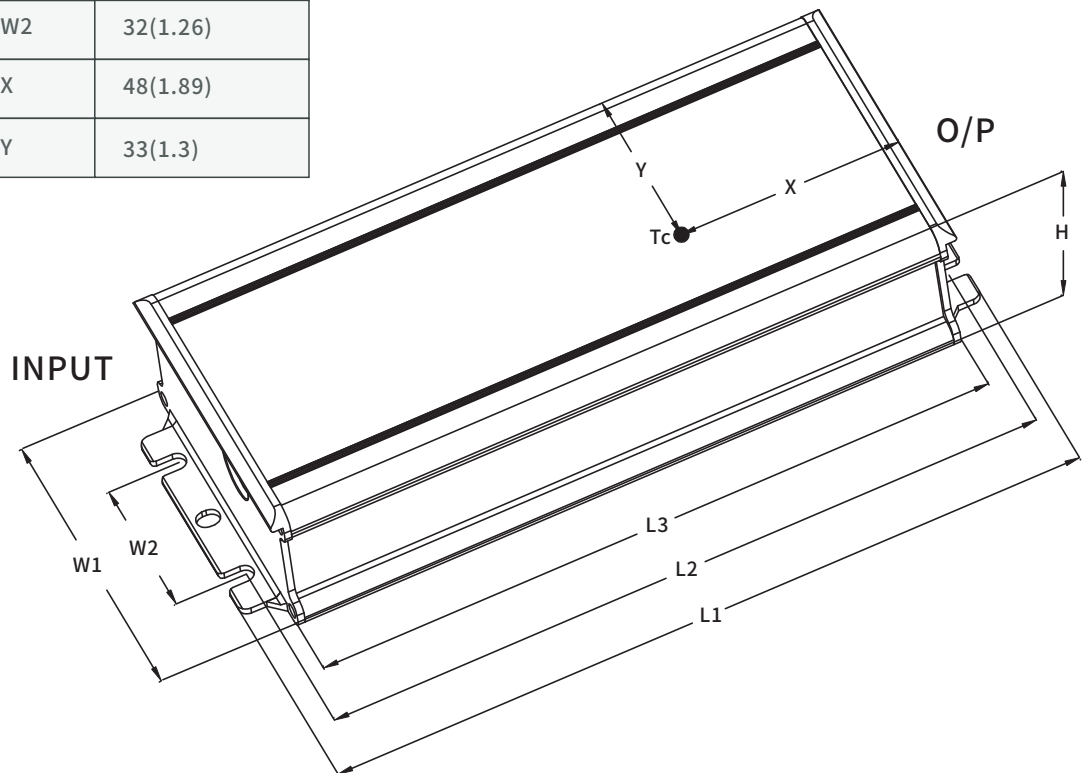

SS-150VH-E Series LED Driver



Assembly Tips

1. Please take isolation and waterproof measures if the dimming cable is not in use.

Package

- Outside carton dimension: $L \times W \times H = 495\text{mm} \times 385\text{mm} \times 162\text{mm}$;
- 14PCS/Carton;
- Net weight/Piece: 0.71kg;Gross weight/Carton: 11.5kg;
- Please refer to the product name, model number, manufacturer identification, QC PASS, manufacturing date on the package.

Transportation

Packaging is designed suitable for transportation by trucks, vessels and flights. The products should be avoided direct sunlight and rain, loaded/unloaded with caution.

Storage

The product storage meets the standard of the GB 3873—83.
Products should be rechecked if stored for over 1 year before assembly.

RoHS

Products comply with RoHS Directive (2011/65/EU) and amendment 2015/863/EU.

Revision History

Version	Description of Update	Updated Date	Remark
V00	Original release	2022/12/12	
V01	Add SS-150VH-E143B/E286B Model	2023/09/08	
V02	Updated working humidity	2024/12/20	